



First in Quality, First in Service.

---

# AIR DISTRIBUTION PRODUCTS

---

VOLUME 1

---



ATLANTIC

# LABORATORY

## PRODUCT APPLICATION

### Supply Venturi Valves

- Medium (0.6 to 3.0 in.w.c.) or low (0.3 to 3.0 in.w.c.) pressure operation
- High-speed actuation
- Characterized and calibrated using NVLAP accredited test stations (Lab Code: 201067-0)
- Operating pressure feedback

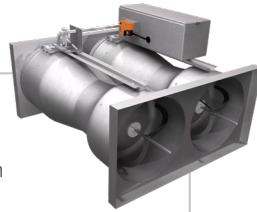

### Pace™

- Pressure or volumetric offset control strategies
- Airflow control utilizing Venturi Valves, Venturi FX Valves or Terminal Units
- High speed room level network for communication to Pace and FHC controllers
- BACnet MS/TP



### Integrated Reheat Coil

- Factory mounted transition
- Coil access door

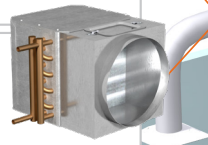

### Room Pressure Sensor

- Maintenance and calibration-free sensor technology
- Accurate to 3% of reading
- Designed to prevent buildup of airborne particulates



### Thermostat

- LCD or blank-face options
- Optional humidity or CO<sub>2</sub> sensing
- Optional connection to room level network for commissioning

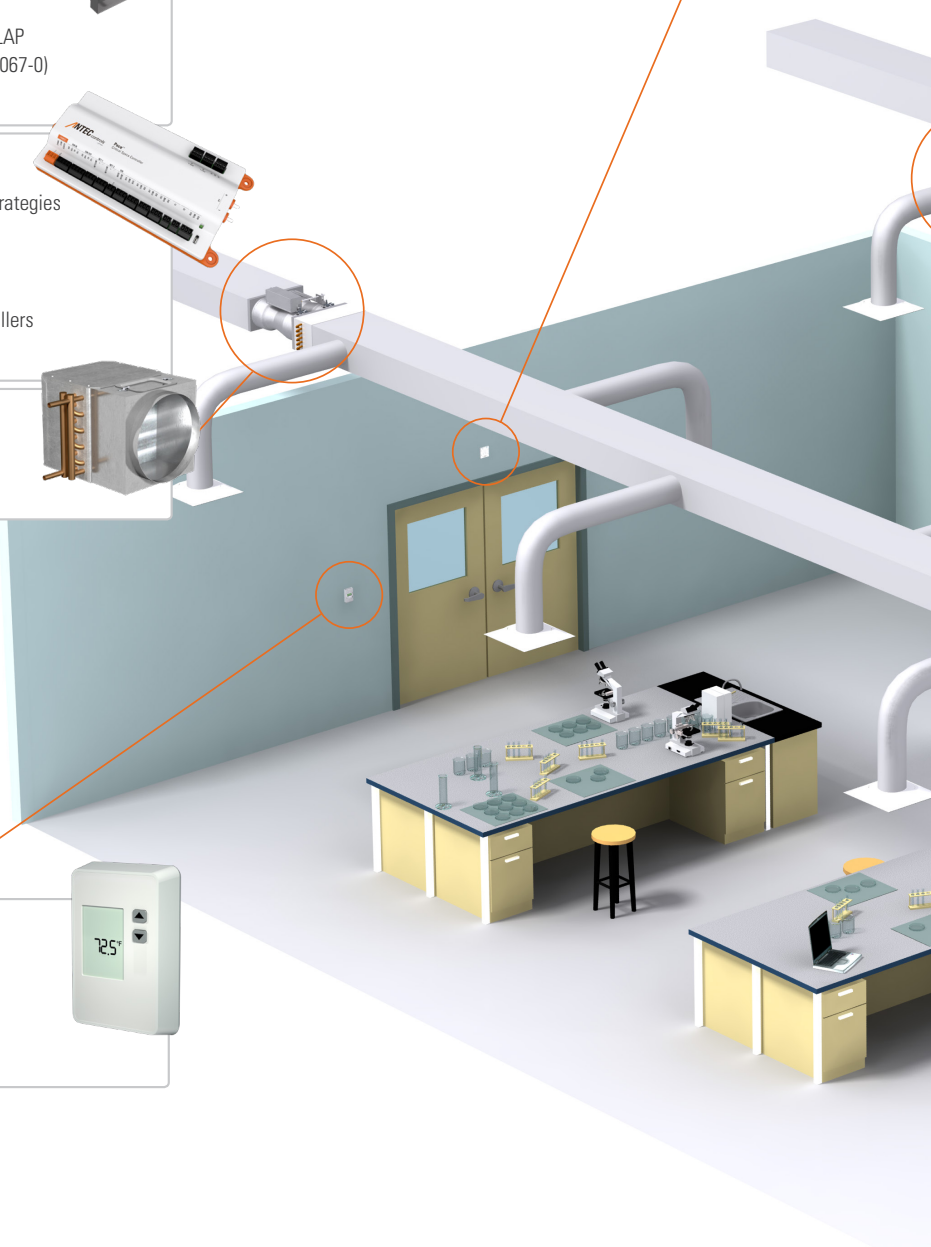

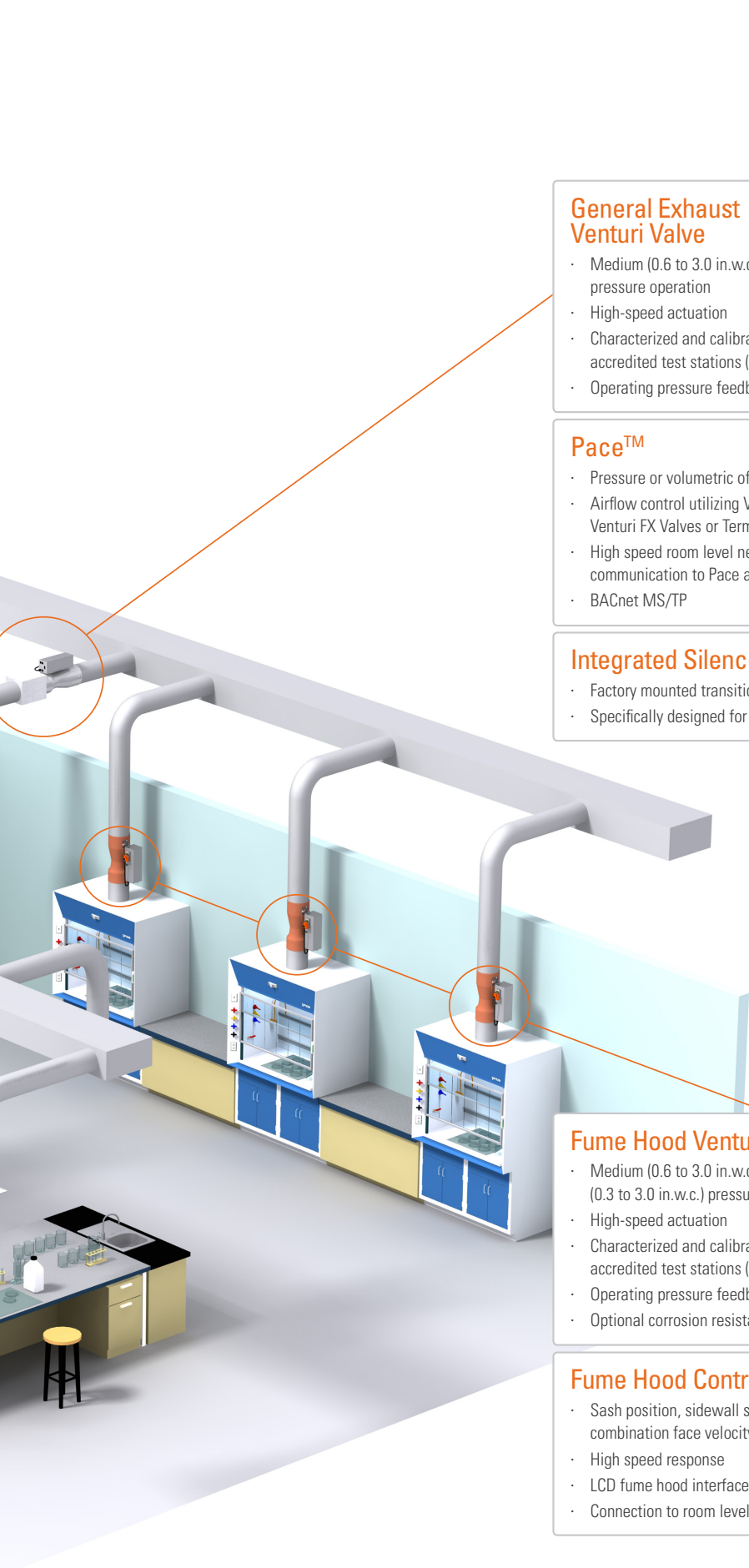

### General Exhaust Venturi Valve

- Medium (0.6 to 3.0 in.w.c.) or low (0.3 to 3.0 in.w.c.) pressure operation
- High-speed actuation
- Characterized and calibrated using NVLAP accredited test stations (Lab Code: 201067-0)
- Operating pressure feedback

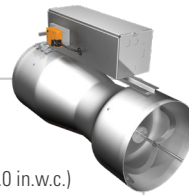

### Pace™

- Pressure or volumetric offset control strategies
- Airflow control utilizing Venturi Valves, Venturi FX Valves or Terminal Units
- High speed room level network for communication to Pace and FHC controllers
- BACnet MS/TP



### Integrated Silencer

- Factory mounted transition
- Specifically designed for Venturi Valves



### Fume Hood Venturi Valve

- Medium (0.6 to 3.0 in.w.c.) or low (0.3 to 3.0 in.w.c.) pressure operation
- High-speed actuation
- Characterized and calibrated using NVLAP accredited test stations (Lab Code: 201067-0)
- Operating pressure feedback
- Optional corrosion resistant coatings

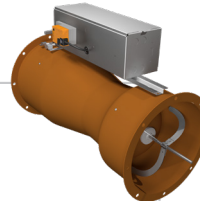

### Fume Hood Controller

- Sash position, sidewall sensor or combination face velocity control
- High speed response
- LCD fume hood interface
- Connection to room level network





Above: Chilled Beams

# ACTIVE & PASSIVE BEAMS



## BUILDING APPLICATIONS

- + Thermal comfort is a major design consideration
- + Spaces with high sensible heat releases
- + Spaces requiring high indoor air quality (100% fresh air)
- + Spaces requiring energy conservation

## AIR-WATER SYSTEM BENEFITS

- + Reduced system power consumption
- + Reduced maintenance costs
- + Environmental quality
  - Improved indoor air quality
  - Improved thermal comfort
- + Reduced mechanical footprint

## ACTIVE & PASSIVE BEAM TYPES

- + Active linear, vertical, horizontal, modular, perimeter induction units, exposed, and floor mounted cabinets
- + Passive linear beams
- + Passive beams with integrated return

## GRILLES, REGISTERS & DIFFUSERS

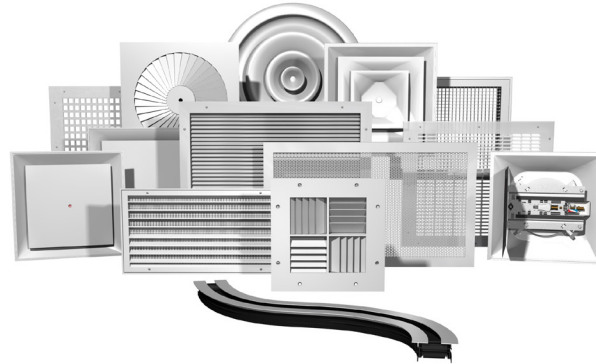

**PRICE** | GRILLES

Price Industries Limited  
[www.priceindustries.com](http://www.priceindustries.com)

- Grilles and Registers
  - Standard Grilles and Registers
  - Linear Bar Grilles
  - Airfoil Series Grilles and Registers
  - Industrial / Special Application
- Filter Grilles
- Condo Grilles
- Nozzles
- Security Products
- Heavy Duty Gym Grilles



**PRICE** | DIFFUSERS

Price Industries Limited  
[www.priceindustries.com](http://www.priceindustries.com)

- Linear Diffusers
  - Custom Flow Linear Diffusers
  - Linear Slot Diffusers
- Ceiling Component Diffusers
  - T-Bar Diffusers
  - Light Troffer Diffusers
  - Low Temperature Diffusers
- Ceiling Diffusers
  - Square Ceiling Diffusers
  - Perforated Ceiling Diffusers
  - Square and Rectangular Directional Diffusers
  - Round Cone Diffusers
  - VAV Diffusers



**PRICE** | DISPLACEMENT

Price Industries Limited  
[www.priceindustries.com](http://www.priceindustries.com)

- Displacement Ventilation
  - Wall Mounted Displacement Diffusers
  - In-Wall Displacement Diffusers
  - Free Standing Displacement Diffusers
- Floor Mounted Displacement Diffusers
- Ceiling Mounted Displacement Diffusers
- Linear Enclosure Displacement Diffusers
- Industrial Displacement Diffusers

**PRICE** | UNDERFLOOR  
**MODUFLEX**

Price Industries Limited  
[www.priceindustries.com](http://www.priceindustries.com)

- Underfloor Air Distribution
  - Round Floor Diffusers
  - Linear Floor Grilles
  - Linear Floor Heaters
  - Power and Control Modules
- Underfloor Terminal Units
- Underfloor Deflection Grilles
- Vertical Fan Column
- Linear Floor Plenums

## GRILLES, REGISTERS & DIFFUSERS CONT'D

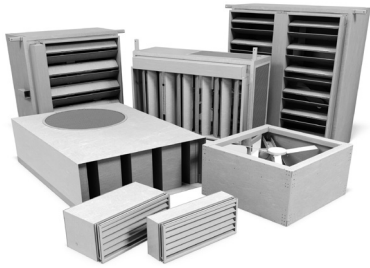

**Price Industries Limited**  
[www.priceindustries.com](http://www.priceindustries.com)

- Natural Ventilation
- Natural Ventilation Roof Stack
- Roof-Mounted Natural Ventilation
- Natural Ventilation Terminal
- Wall-Mounted Air Transfer Unit



**Acutherm**  
[www.acutherm.com](http://www.acutherm.com)

- Square VAV Diffusers
- Round VAV Diffusers
- Linear VAV Diffusers
- Pressure Control Products
- Temperature Control Products



**Seiho**  
[www.seiho.com](http://www.seiho.com)

- Turbo Nozzles
- Diffusers - Mini or Spot
- Grilles
- Dryer Vent Caps
- Vent Louvers



**Air Concepts Inc.**  
[www.airconceptsinc.com](http://www.airconceptsinc.com)

- Directional Air Distribution Products
- Punkah Diffusers
- Nozzle Diffusers
- Industrial Diffusers

# DAMPERS

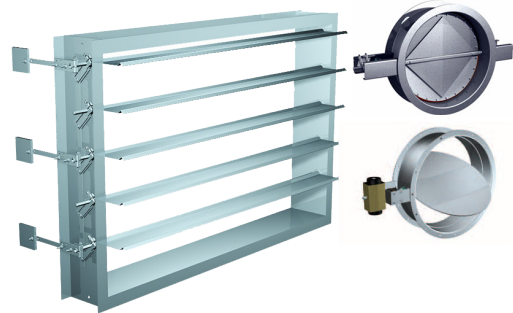

**Price Industries Limited**  
[www.priceindustries.com](http://www.priceindustries.com)

- Fire Dampers
- Smoke Dampers
- Fire / Smoke Dampers
- Ceiling Radiation Dampers
- Backdraft Dampers
- Control and Balancing Dampers
- Actuators
- Access Doors



**Greenheck**  
[www.greencheck.com](http://www.greenheck.com)

- Dampers
  - Smoke
  - Fire / Smoke
  - Manual Balancing
  - Commercial Control
- Heavy Duty Industrial
- Commercial Back Draft
- Commercial Barometric Relief
- Heavy Duty Industrial Backdraft

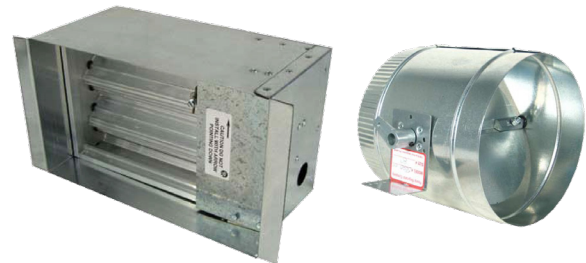

**TAMCO Innovative Damper Products**  
[www.tamco.ca](http://www.tamco.ca)

- Premium Quality:
  - Thermally Insulated / Thermally Broken Frame Control Dampers
  - Aluminum Air-Foil Control Dampers
  - High Quality Aluminum Backdraft Dampers



**Young Regulator**  
[www.youngregulator.com](http://www.youngregulator.com)

- Bowden Remote Control Dampers and Controllers
- Damper Regulators
- Manual Dampers
- Automatic Changeover Dampers
- Motorized Dampers

## LOUVERS

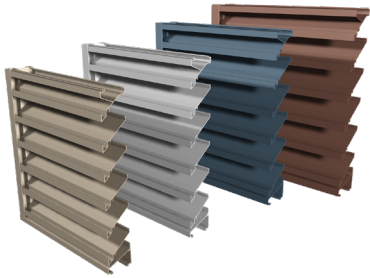

**Price Industries Limited**  
[www.priceindustries.com](http://www.priceindustries.com)

- Formed Metal Louvers
- Extruded Louvers
- Standard Blade and Chevron Blade Acoustical Louvers
- Extruded Penthouse Louvers
- Formed Metal Penthouse Louvers
- Thinline Wall Application Louvers
- Rain Storm Louvers
- Wind-Driven Rain Louvers
- Sand Louvers
- Vision Screens
- Sightproof Louvers
- Louvered Shapes
- Louvered Doors
- Sunshades
- Equipment Screens
- Architectural Louvers
- Special Louvers as per Request



**Air Louvers Inc.**  
[www.activarcpg.com/air-louvers](http://www.activarcpg.com/air-louvers)

- Door Louvers
  - Fire Rated
  - Non-Vision
  - Lightproof for Dark-rooms and X-Ray Rooms
  - Adjustable
  - Stormproof with Water Baffle
- Severe Windstorm Rated
- Security
- Vision Lites
- Fire-Rated and Impact-Rated Glass



**Greenheck**  
[www.greenheck.com](http://www.greenheck.com)

- Sightproof Extruded Louvers
- Wind-Driven Rain Resistant Extruded Louvers
- Extruded Louvers with Integral Motorized Dampers
- Sand Louvers
- Penthouses and Penthouse Elevator Vents
- Brick Vents
- Equipment Screens



**Biddle Climate Solutions**  
[www.biddle.ca](http://www.biddle.ca)

- Commercial, Retail and Industrial Air Curtains
- NOZ Adjustable Nozzle Unit Heater for High Induction





## NOISE & VIBRATION ISOLATION

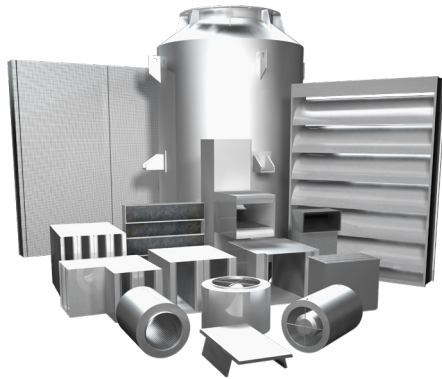

Price Industries Limited  
www.priceindustries.com



The VMC Group  
www.themvcgroup.com

- Commercial and Custom Silencers
- Rectangular, Elbow and Circular Silencers
- Absorptive, Film-Lined and Packless Silencers

- Air Transfer and Cross-Talk Silencers
- Acoustic Panels, Enclosures and Barriers
- Acoustical Louvers

- Floor Mounted Isolators
- Bases, Rails and Brackets
- Hangers
- Pad-Type Isolators
- Flexible Connectors
- Piping Specialties
- Seismic Products
- Floating Floors

## AIR FILTRATION - STANDARD & CRITICAL EXHAUST

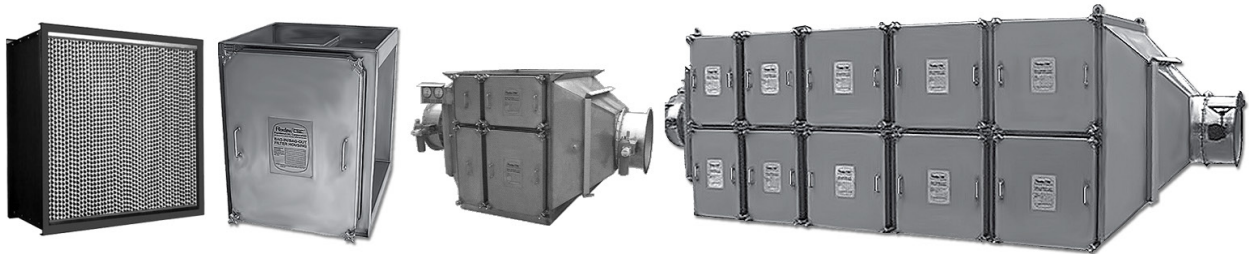

AAF Flanders  
www.aafintl.com

- Disposable Air Filters
- Air Filter Media and Auto Rolls
- Pleated Filters
- Medium and High Efficiency Rigid Type Air Filters

- Medium and High Efficiency Extended Surface Type Bag Filters
- Metal Washable Air and Grease Filters
- Odor Control Filters
- Carbon Absorbers

- 95% DOP and HEPA / ULPA Filters
- HEPA Housings and Holding Frames
- ASHRAE Side Access Housings and Holding Frames

- Cleanroom Ceiling Filters and Hoods
- Gaseous / Vapor Phase Sideload and Front Load Housings
- FCP Containment Air Filtration Systems (Bag-In / Bag-Out)

## LABORATORY, CRITICAL ENVIRONMENT & SPECIALIZED EXHAUST PRODUCTS

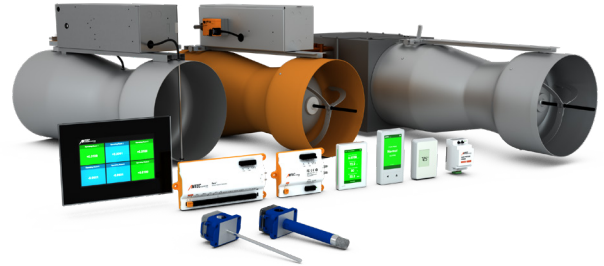

Price Industries Limited  
[www.priceindustries.com](http://www.priceindustries.com)

- Ultrasuite O.R. System
- Common Plenum Laminar Array
- Hospital Grade Ceiling Systems
- Air Curtain Systems (HORD System)
- Fan Filter Units
- Laminar Flow Diffusers
- Radial Flow Diffusers
- Return and Exhaust Grilles
- Fume Hoods

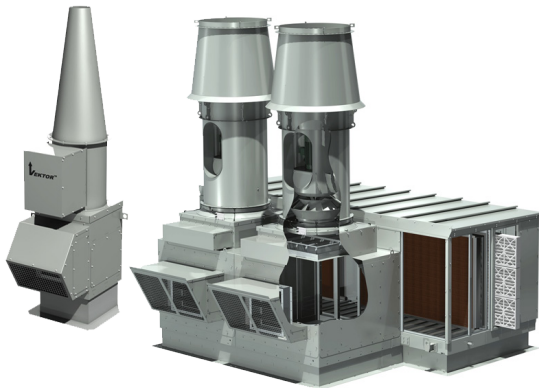

Greenheck  
[www.greenheck.com](http://www.greenheck.com)

- Laboratory Exhaust Systems



Antec Controls  
[www.antecontrols.com](http://www.antecontrols.com)

- Valves
  - Venturi Valves – High Turndown Ratio and Mechanical Pressure Independence
  - Venturi FX – Measured Airflow and Low Pressure Operation
  - Integrated Venturi Valve Assembly Options
    - Performance Guaranteed Venturi with Integrated Silencer Assemblies
    - AHRI 410 Certified Venturi with Hot Water Coil Assemblies
    - UL1995 Certified Venturi with Electric Coil Assemblies
- Monitors and Controls
  - Room Monitors
    - Touchscreen Room Pressure Monitor – High Resolution Touchscreen Display
  - Multi-Variable Monitor – High Resolution Touchscreen Displaying up to 8 Rooms on Main Screen
  - All Monitors Have Native BACnet MS / TP Connection
  - Pace™ Critical Space Controller
    - Volumetric Offset or Pressure Control
    - Temperature and Humidity Control
  - Fume Hood Controls
    - Fume Hood Controller
      - Sash Position Sensing Fume Hood Control
      - Sidewall Sensing Fume Hood Control
      - Hybrid Fume Hood Control
      - Presence Sensing
    - Fume Hood Interface

## LABORATORY, CRITICAL ENVIRONMENT & SPECIALIZED EXHAUST PRODUCTS



### Nederman

**Nederman**  
www.nederman.com

- Fume Extraction Arms and Fans
- Bench Top Flexible Extraction Arms and Fume Cabinets
- Filter Carts and Filter Box Mobile Fume Extractors
- Vehicle Exhaust Fume Extractors and Hose Reels
- Fume Extraction Rail Systems
- Electrostatic and Oil Mist Filters
- Magna Track Fire Station Exhaust Extractors for Rescue Vehicles
- Dust Collectors
- Nordfab Industrial Ductwork



**Kewaunee**  
www.kewaunee.com

- Fume Hoods
- BioSafety Cabinets

## FABRIC DUCT

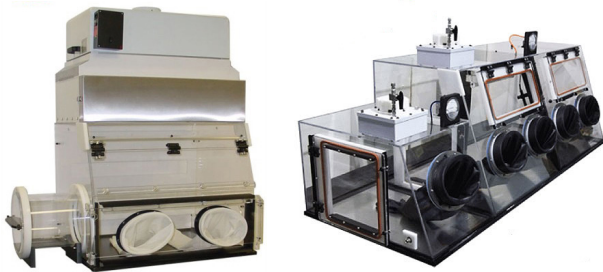

**Flow Sciences**  
www.flowsciences.com

- Benchtop / Scale Up
- Contained Environmental Systems
- Nanotechnology
- Lab Automation / Robotic Equipment
- Pilot Plant / Manufacturing
- Specialty Hoods



**DuctSox**  
www.ductsox.com

- Fabric Duct Ventilation
- Fabric Faced Diffusers
- Final Filters

# FANS



**Fantech**  
[www.fantech.net](http://www.fantech.net)

- Inline Duct Fans
- Bathroom / Kitchen Exhaust Fans
- Round Backdraft Dampers
- Lint Traps
- Heat Recovery Ventilators



**Delhi**  
[www.delhi-industries.com](http://www.delhi-industries.com)

- Commercial Fans
  - Duct Blowers
  - Roof Exhausters
  - Direct Drive Tube Axial
  - Belt Drive Tube Axial
- Fresh Air Supply Units
- Utility Blowers
- DWDI-FC Blowers
- DWDI-BIDI Blowers



**Venmar**  
[www.venmar.ca](http://www.venmar.ca)

- Kitchen Range Hoods
- Exhaust Fans
- Ventilators



**Reversomatic**  
[www.reversomatic.com](http://www.reversomatic.com)

- Condominium Fans
- Commercial Fans and Range Hoods



**Big Ass Fans**  
[www.bigassfans.com](http://www.bigassfans.com)

- Large Fans for Commercial and Industrial Applications
  - Summer Cooling
  - Winter Destratification / Heat Recirculation
- High Volume, Low Speed Fans 8' to 24' in Diameter



**Plastec Ventilation, Inc.**  
[www.plastecvent.net](http://www.plastecvent.net)

- Corrosive Resistant Polypropylene Fans and Blowers
- Centrifugal Fans
- Inline Centrifugal Fans
- Stainless Steel Blowers

## FANS CONT'D



### Panasonic

**Panasonic**  
[www.panasonic.com/building](http://www.panasonic.com/building)

- Advanced Ceiling Ventilation Fans
- Fan / Light Combinations
- Fan / Heat Combinations
- Super Quiet Inline Fans
- Through-the-Wall Ventilation Fans



### LIFE BREATH

Indoor Air Systems

**Lifebreath**  
[www.lifebreath.com](http://www.lifebreath.com)

- Inline Fans
- Heat Recovery Ventilators
- Turbulent Flow Precipitators
- Clean Air Furnace



**Canarm/Delhi/Leaderfan**  
[www.canarm.com](http://www.canarm.com)

- Industrial High Performance Ceiling Fans
- Roof Supply and Exhaust Fans
- Wall Supply and Exhaust Fans
- Inline Duct Fan
- Man Coolers
- Circulating Fans



**BANVIL 2000**

**Envirofan** **Banvil 2000**  
[www.envirofan.com](http://www.envirofan.com) [www.banvil2000.com](http://www.banvil2000.com)

- Ceiling Destratification Fans
- Industrial Ceiling Fans

## KITCHEN VENTILATION SYSTEMS

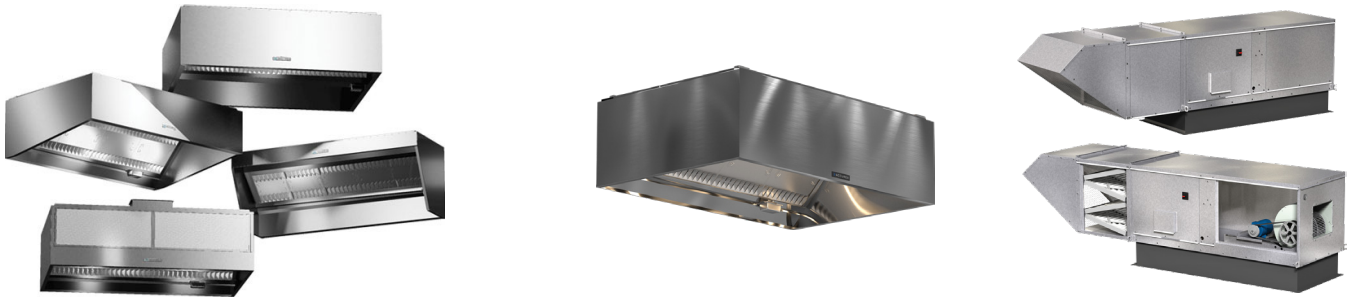

**Greenheck**  
[www.greenheck.com](http://www.greenheck.com)

- Wall, Island Proximity and Heat Condensate Hoods
- Internal and External Supply Plenums Optional
- Standard Baffle Filter, High Velocity Cartridge
- FlexConnect Utility Distribution System
  - Factory Built Wall Utility Systems Offering Single Point Connections for Gas, Water and Electricity
  - Easy to Clean Stainless Steel Exterior

## ELECTRIC HEATING

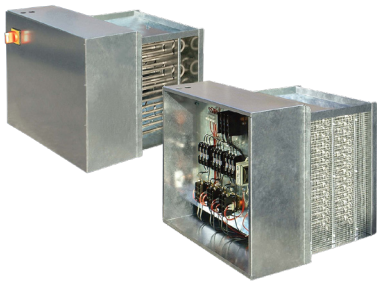

**Price Industries Limited**  
[www.priceindustries.com](http://www.priceindustries.com)

- Electric Duct Heaters
  - Open or Tubular Coils



**Neptronic**  
[www.neptronic.com](http://www.neptronic.com)

- Electric and Gas Fired Humidifiers
- Steam-to-Steam and Direct Steam Humidifiers
- Atomizing Humidifiers
- Evaporative Humidifiers
- Steam Distribution Systems
- Humidity Controls
- Actuators
- Actuated Valves
- Electric Heaters
- HVAC Controls

## FAN COILS & HYDRONIC HEATING AND COOLING

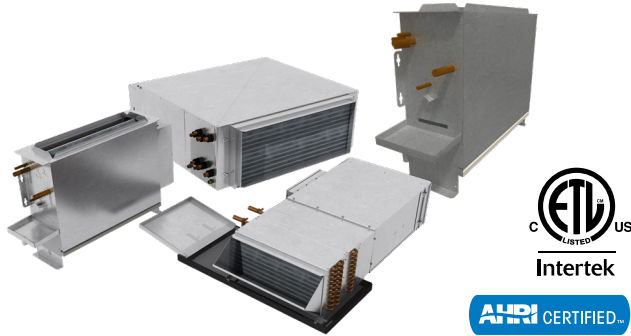

### PRICE | FAN COILS

Price Industries Limited  
[www.priceindustries.com](http://www.priceindustries.com)

- High Performance Fan Coils
  - Optional Integrated Silencer
  - Standard ECM Motor
- Horizontal Blower Coils
  - Vertical Fan Coils
  - Concealed and Exposed

### PRICE | BEAMS

Price Industries Limited  
[www.priceindustries.com](http://www.priceindustries.com)

- Chilled Beams
  - Linear, Modular, Horizontal, Vertical and Floor-Mounted Active
  - Linear Passive
- Passive with Integrated Returns
  - Controls and Hose Kits
- Retrofit Perimeter Induction Units



## TERMINAL UNITS



### GREENHECK Building Value in Air.

Greenheck  
[www.greenheck.com](http://www.greenheck.com)

- High Performance Fan Coils
- Coils
  - Chilled Water
  - Hot Water
  - DX Evaporator
- Heat Reclaim
- Condenser
- Standard Steam
- Non-Freeze Steam Distributing
- Booster / Duct Mounted

### PRICE | TERMINALS

Price Industries Limited  
[www.priceindustries.com](http://www.priceindustries.com)

- Single Duct Terminal Units
- Bypass Controller Type Terminal Unit
- Control Valves
- Dual Duct Terminal Units
- Fan Powered Terminal Units
- Induction Terminal Units
- Retrofit Terminal Units
- Special Application Terminal Units

## HEAT & ENERGY RECOVERY

---



**SolutionAir**  
[www.solutionairgroup.com](http://www.solutionairgroup.com)

- RegenCore Alternating Mass-Exchanger Energy Recovery Units
- Up to 92% Effectiveness
- No Pre-Heat Requirements Down to Outdoor Temperatures of -40°C

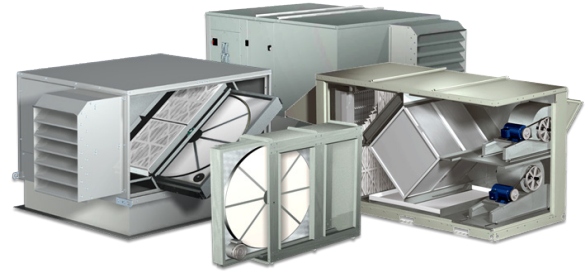

**Greenheck**  
[www.greenheck.com](http://www.greenheck.com)

- Minivent Interior ERV
- PVE Plate Heat Exchanger
- ERV and ERVE Energy Recovery Units
- RVE Packaged Air Handler with Integral Energy Recovery

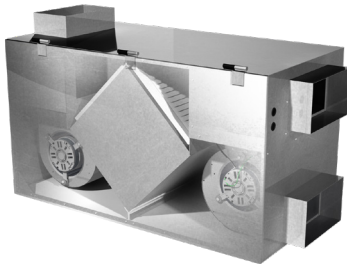

**Nu-Air Ventilation**  
[www.nu-airventilation.com](http://www.nu-airventilation.com)

- Residential HRVs and ERVs
- Commercial HRVs and ERVs
- Enerboss Integrated Air Handlers and Fan Coils
- Air Exchangers, Passive HRVs and Wet Basement Solutions
- Controls and Accessories



# CONTROLS



## PRICE | CONTROLS

Price Industries Limited  
[www.priceindustries.com](http://www.priceindustries.com)

- Application Specific Controls for:
  - Networked or Stand-Alone Applications
  - VAV / VVT Controllers (BTL Certified)
  - Mini-Front-End Solutions
- Pneumatic Stand-Alone Controls
- Control Applications:
  - Rooftop Controls
  - Bypass Controls
  - Single Duct Controls
  - Fan Powered Controls
  - Prodigy Smart Diffusers
  - Web Server Graphical Interface
  - Hydronic Controls
  - Underfloor Controls

## FRANKLIN CONTROL SYSTEMS

Franklin Control Systems  
[www.franklin-controls.com](http://www.franklin-controls.com)

- HVAC Specialty Products
  - Building Automation Starters
  - Standard Automation Starters
  - Cooling Tower Controls
  - Kitchen Hood Controls
  - Pump and HVAC Controls
- Industrial Products
  - Contactors and Overload Relays
  - Manual Motor Starters
  - Circuit Breakers
  - Starters
  - Soft Starters
  - Soft Starters with Integrated Bypass
  - Programmable Logic Controllers
  - Terminal Blocks
  - Pilot-Devices
  - Enclosures



## BELIMO

Belimo  
[www.belimo.com](http://www.belimo.com)

- Electronic Control Valves
- Zone Control Valves
- Globe Valves
- Butterfly Valves
- Actuators

## MAKE-UP AIR UNITS & AIR HANDLERS



**SolutionAir**  
www.solutionairgroup.com



**Greenheck**  
www.greenheck.com

- Air-Cooled DOAS Units
  - Up to 20,000 CFM
  - Heating Options: Gas, Electric, Steam and Hydronic
  - Cooling Options: Hydronic and DX (Packaged or Split)
  - Energy Recovery Options
- Customizable Air Handlers
  - Up to 100,000 CFM
  - Indoor / Outdoor Construction
  - Single / Double Wall Construction
  - Heating Options: Gas, Electric, Steam and Hydronic
  - Cooling Options: Hydronic and DX (Packaged or Split)
  - Energy Recovery
  - Packaged Control
- Make-Up Air Units
  - Direct Fired: 250 – 15,000 MBH
  - Indirect Fired Drum and Tube: 200 – 6,000 MBH
  - Indirect Fired Convolution Tube: 75 – 1,200 MBH
  - 90% Efficient Indirect Fired: 250 – 1,600 MBH
- Rooftop Units (8 – 250 Tons)
  - Highly Configurable
  - Heating Options: Indirect Gas, Electric, Steam and Hydronic
  - Cooling Options: Hydronic and DX (Packaged Up to 160 Tons and Split Up to 250 Tons)
  - Energy Recovery Options

- Direct and Indirect Gas Fired Make-Up Air Units
- Indoor Air Handling Units
- Electric Heating, Hot Water, Chilled Water and DX Options

## MOISTURE CONTROL

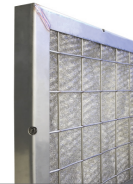

**Mistop Moisture Eliminator**  
www.mistop.com

- Innovative Solutions for Moisture Control in HVAC Systems Including Melting Snow and Moisture Eliminators



# SMART STARTERS AND VFDs

Advanced Across the Line Solutions for HVAC Applications

## HVAC Specialty Products

- Building Automation Starters
- Standard Automation Starters
- Cooling Tower Controls
- Kitchen Hood Controls
- Pump and HVAC Controls



NEMA Rated  



## Industrial Products

- Contactors and Overload Relays
- Manual Motor Starters
- Circuit Breakers
- Starters
- Soft Starters
- Soft Starters with Integrated Bypass
- Programmable Logic Controllers
- Terminal Blocks
- Pilot-Devices
- Enclosures



[www.franklin-controls.com](http://www.franklin-controls.com)



## Creating Safe & Clean Work Environments

- Fume Extraction Arms and Fans
- Bench Top Flexible Extraction Arms and Fume Cabinets
- Filter Carts and Filter Box Mobile Fume Extractors
- Vehicle Exhaust Fume Extractors and Hose Reels
- Fume Extraction Rail Systems
- Electrostatic and Oil Mist Filters
- Magna Track Fire Station Exhaust Extractors for Rescue Vehicles

**Nederman**

[www.nederman.com](http://www.nederman.com)

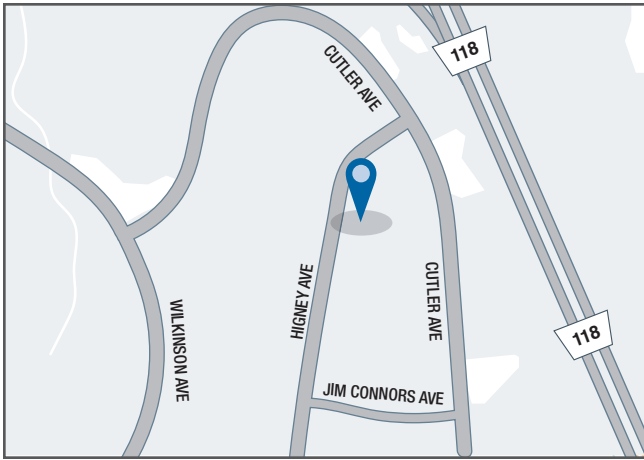

## E.H. PRICE DARTMOUTH

420 Higney Avenue  
Dartmouth, Nova Scotia

B3B 0L4

Ph: 902.468.1310

Email: [dartmouth@ehpricesales.com](mailto:dartmouth@ehpricesales.com)

**Website:** [www.ehpricedartmouth.com](http://www.ehpricedartmouth.com)

Local Delivery Available

Contact your E.H. Price Sales Representative for more information

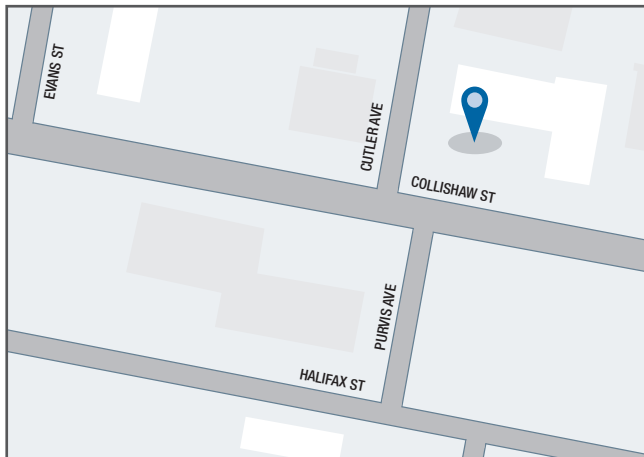

## E.H. PRICE MONCTON

255 Collishaw Street  
Moncton, New Brunswick

E1C 9P9

Ph: 506.800.8062

Email: [moncton@ehpricesales.com](mailto:moncton@ehpricesales.com)

**Website:** [www.ehpricemoncton.com](http://www.ehpricemoncton.com)

Local Delivery Available

Contact your E.H. Price Sales Representative for more information

# e.h. price

**First in Quality, First in Service**